

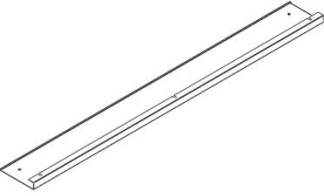

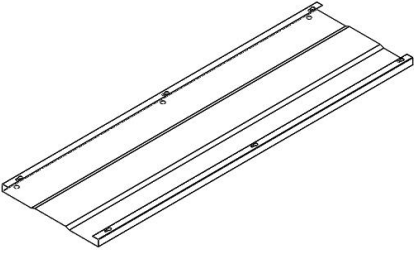

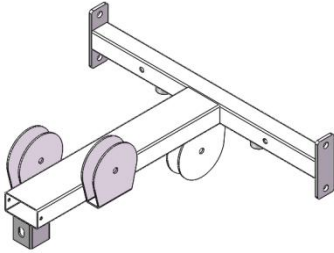

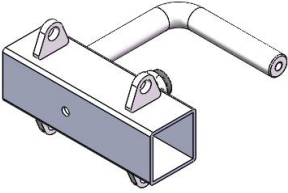
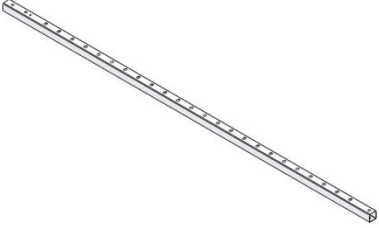
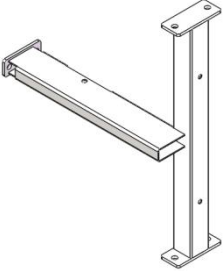
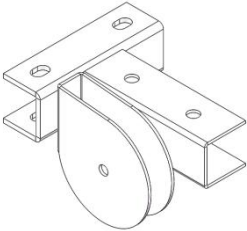

Bolt Strength Single Cable Column

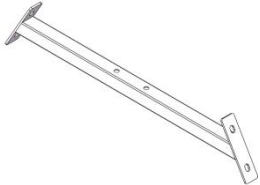
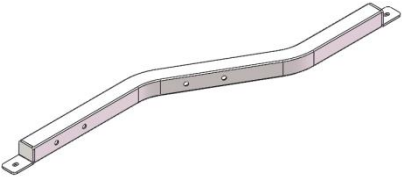

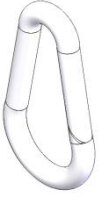
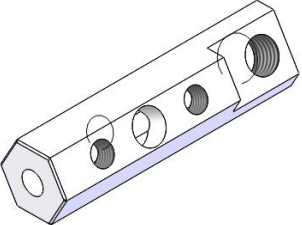

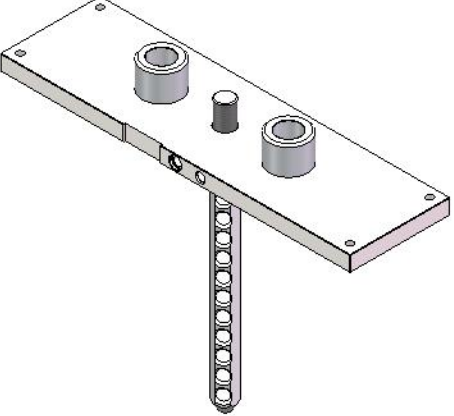
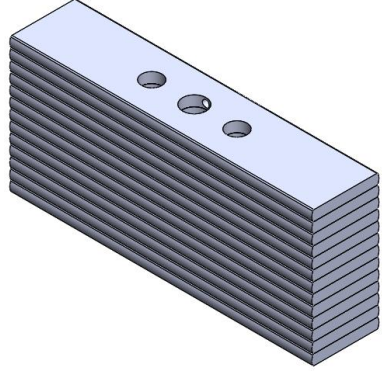
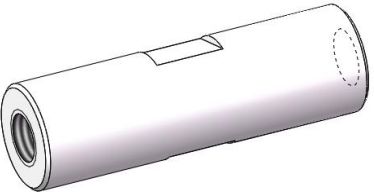
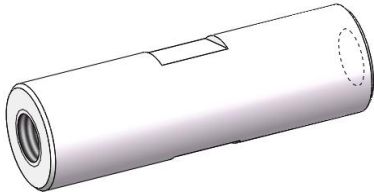

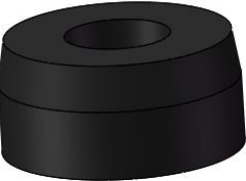
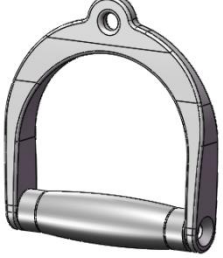
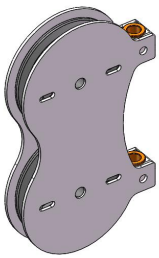
Parts list-1 (individual packaging)

					
NO 1	Front cover ,one left ,one right; one pcs with logo	NO 2	Back cover : 1pcs	NO 3	Upper welding group: 1set
					
NO 4	Sliding components 1	NO 5	Adjusting tube 1pcs	NO 6	Down welding group: 1pcs
					
NO 7	connection fixed group: 1pcs	NO 8	Small movable pulley set: one pcs	NO 9	Base connecting rod: 1 pcs
					
NO 10	The base group: left and right ,2pcs	NO 11	2 columns	NO 12	Locking thread head buffer sleeve: 2pcs

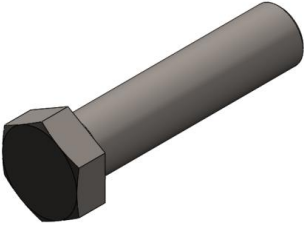
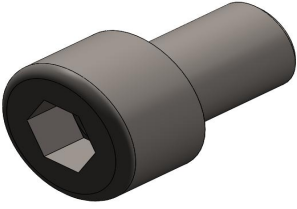
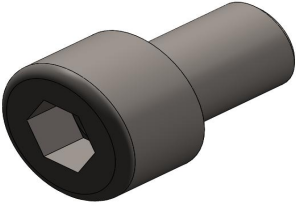
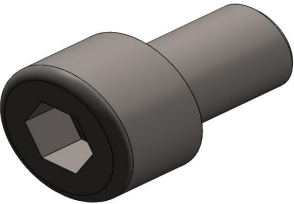
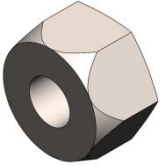
					
NO 13	lockout coil:2pcs	NO 14	Lock head: 3pcs	NO 15	Cable lock ball: 2pcs
					
NO 16	Weight stack pin: 1pcs	NO 17	First weight stack group: 1pcs	NO 18	Weight stack group
					
NO 19	Long connect column:2pcs	NO 20	Short connect column:2pcs	NO 21	Guild rod: 2pcs
					
NO 22	Rubber mat:2pcs	NO 23	Handle: 2pcs	NO 24	Pulley group:2pcs

Blister packaging screw specification-2

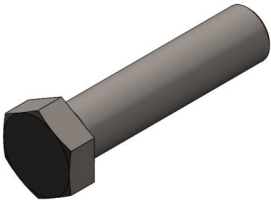
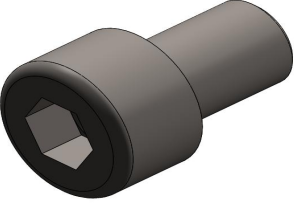
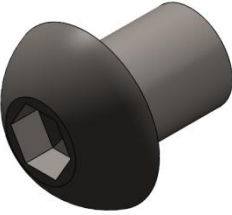
					
A	M12*80 hex screw 17pcs	B	M8*12 Hex Socket 12pcs	C	M8*55 Hex Socket 2pcs
					
D	M8*65 hex screw 2pcs	E	M12 Lock nut 24pcs	F	M12 washer 40pcs
					
G	M8 washer 36pcs	H	M8*16 Jack-screw 9pcs	I	M12*75 hex screw 3pcs
					
J	M12*55 inner hexagon screw 4pcs	K	M8*14 Hexagon socket with half round head 4pcs		

Assembling steps

Step NO	Item NO	Name	Qty	Item NO	Name	Qty
1	NO 10	Floor part	One left, one right	A	hex screw M12*80	6
	NO 7	Fix connection group	1	E	Lock nut M12	6
	NO 9	Base connect group	1	F	Washer	12
Tools		Hexagon socket screw driver, wrench				

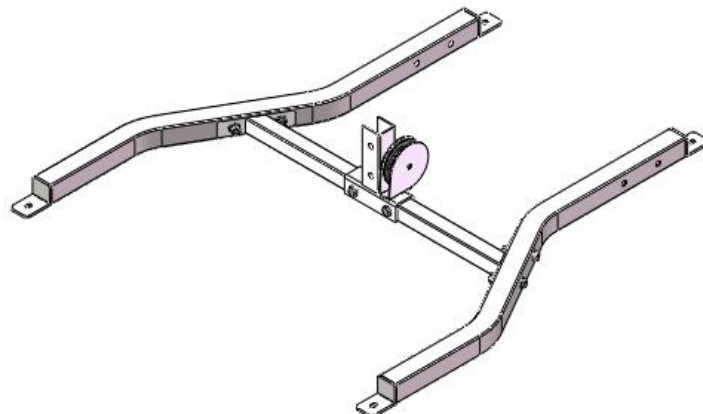
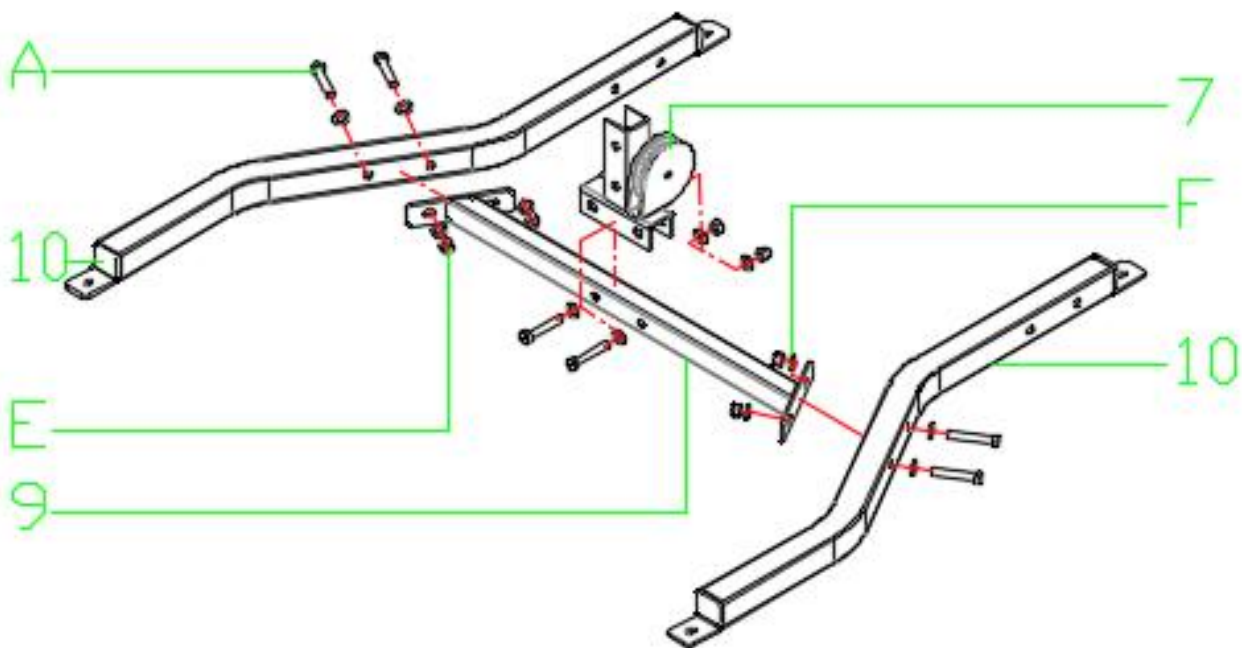

Assembling steps

Step NO	Item NO	Name	Qty	Item NO	Name	Qty
2	N03	Upper connect part	1	A	M12*80 hex screw	12
	N04	Sliding group	1	E	M12 washer	30
	N05	Adjust column	1	F	M12 Lock nut	15
	N06	Down connect column	1	I	M12*75 hex screw	3
	N011	Standing column	2			

Tools

Hexagon socket screw driver, wrench

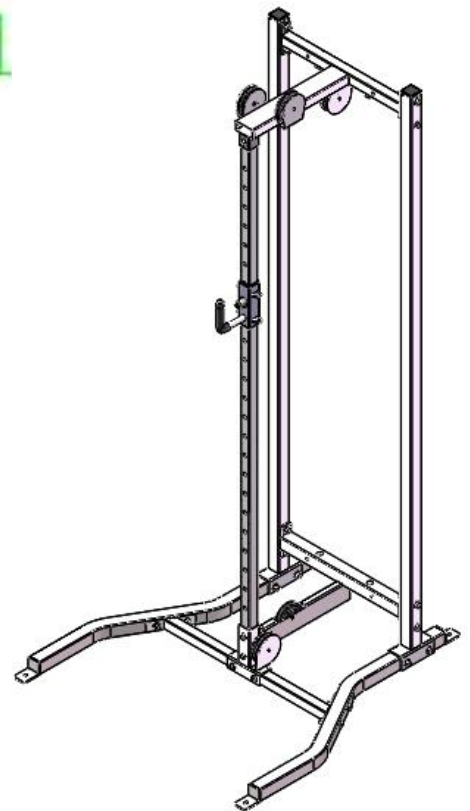
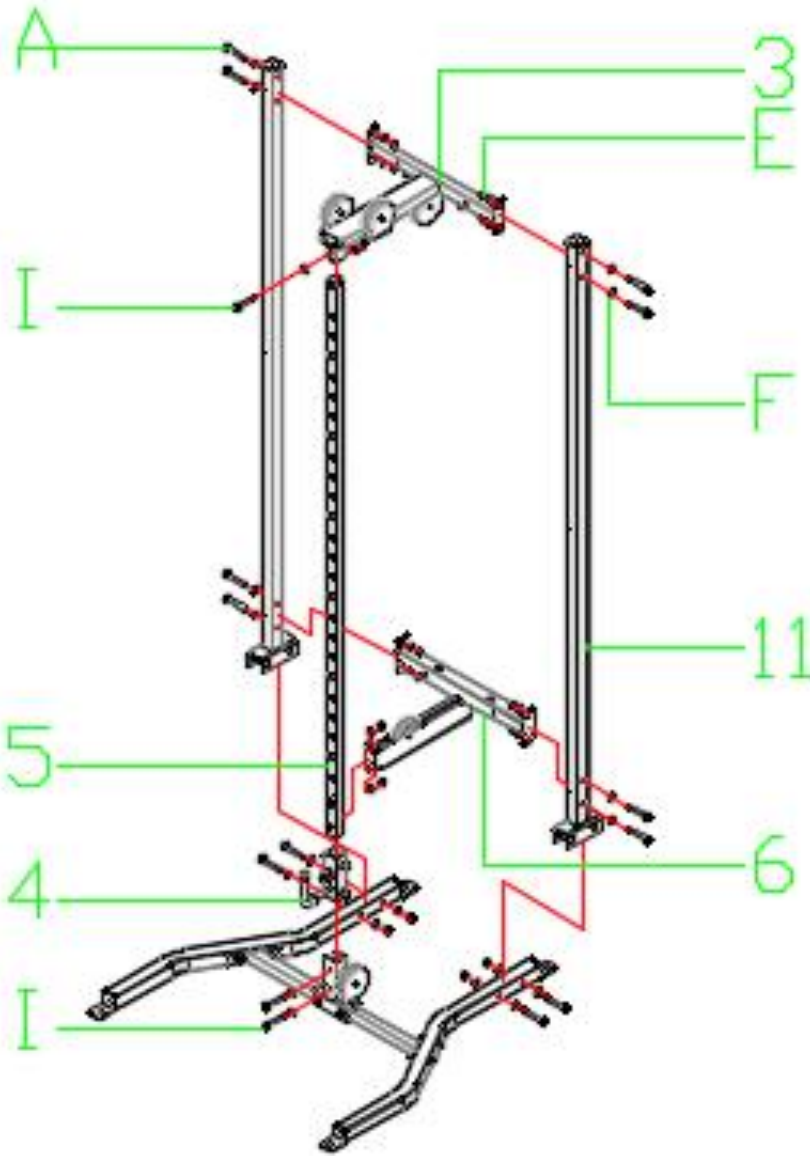

Assembling steps

Step NO	Item NO	Name	Qty	Item NO	Name	Qty
3	NO 1	Front cover	One left, one right	NO 21	Guide rod	2
	NO 2	Back cover	1	NO 22	Rubber mat	2
	NO 9	Movable block	1	NO 24	Movable pulley	2
	NO 16	Weight stack pin	1	B	M8*12 hexagon socket head cap screw	12
	NO 17	First weight stack part	1	C	M8*55 hexagon socket head cap screw	2
	NO 18	Weight stack group	1	E	M12 Lock nut	4
	NO 19	Long connect column	1	G	M8 washer	36
	NO 20	Short connect column	1	J	M12*55 hex screw	4
	D	M8*65 hex screw	2	K	M8*14 Hexagon socket with half round head	4

Tools

Hexagon socket screw driver, wrench

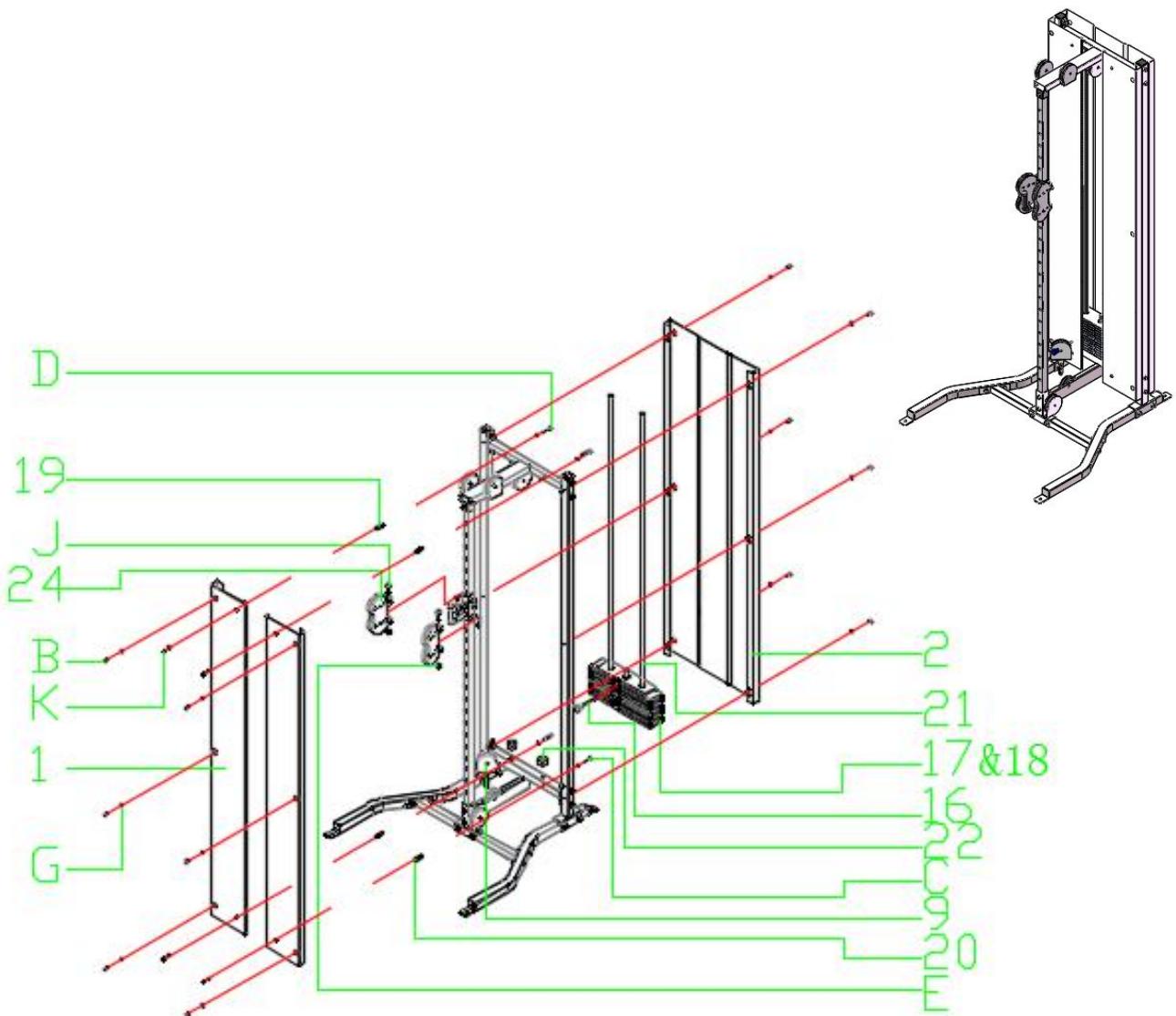

Cable diagram

Step NO	Item NO	Name	Qty	Item NO	Name	Qty
4						

Tools

Hexagon socket screw driver, wrench

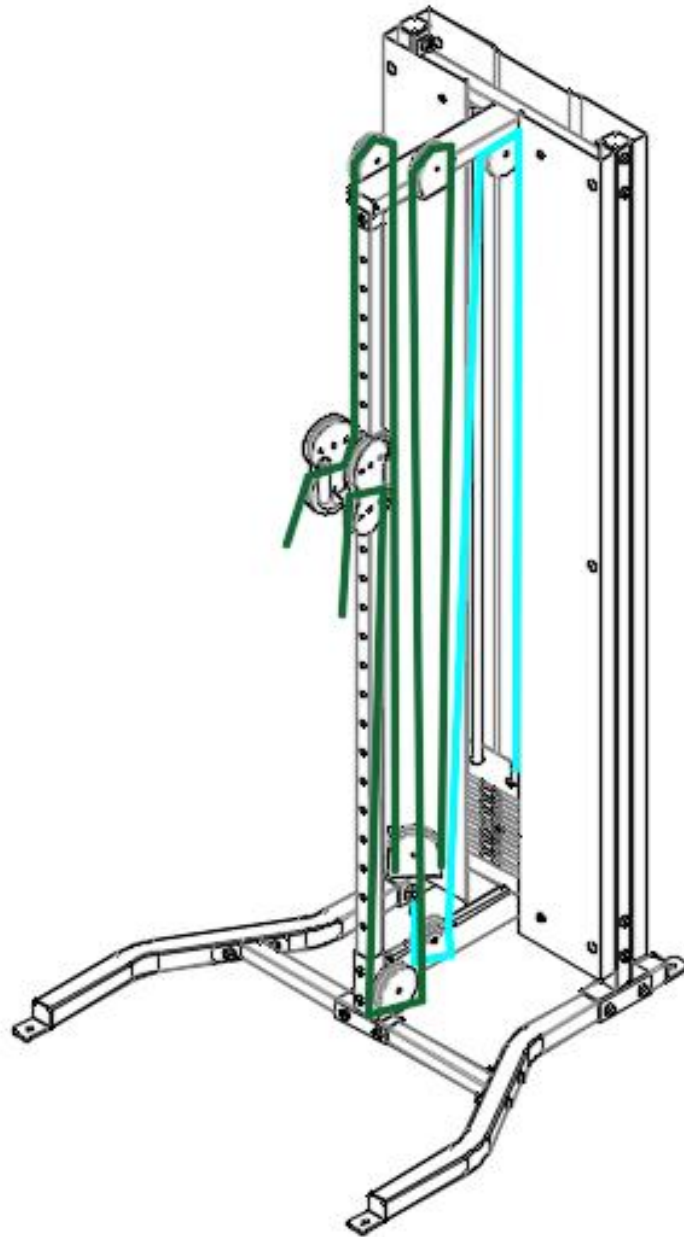

Assembling steps

Step NO	Item NO	Name	Qty	Item NO	Name	Qty
5	N012	Cushion sleeve of locking thread	2	N013	Lock biner	2
	N014	Lock head	2	N015	Cable lock ball	2
	N023	Handle	2	H	Jack screw M8*16	6
Tools		Hexagon socket screw driver, wrench				

